

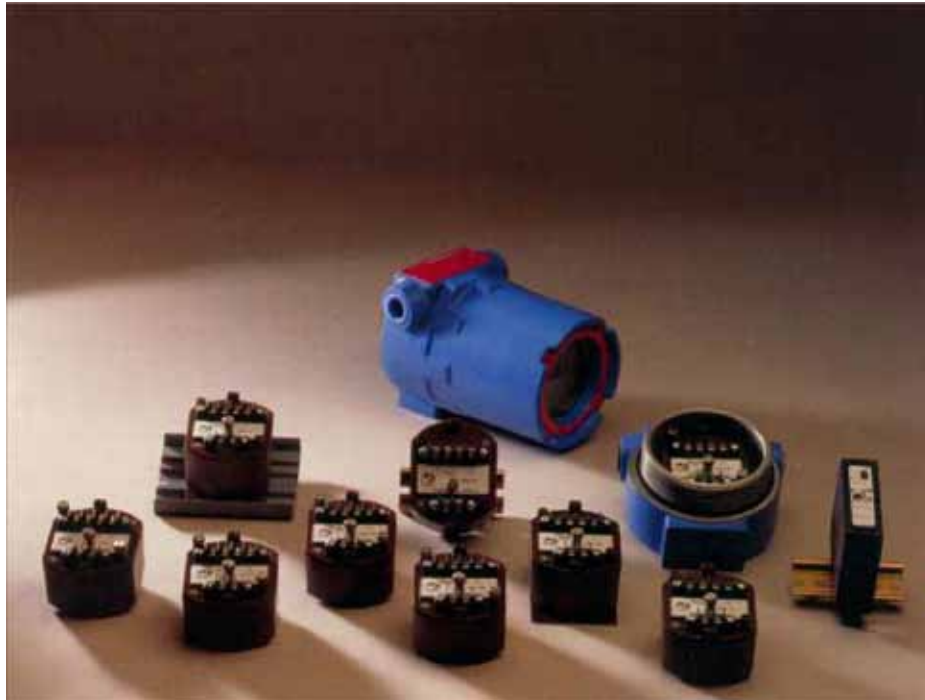

ADTECH

95 Mt. Read Blvd # 149
Rochester, New York 14611 USA
Phone: 1.585.698.1845
Fax: 1.585.697.0445

100 SERIES TWO-WIRE FIELD SELECTABLE WIDE RANGING TRANSMITTERS GUIDE



FEATURES

- TYPES OF INPUTS: AC CURRENT & VOLTAGE, FREQUENCY, MILLIVOLTS, POTENTIOMETER, RTD, THERMOCOUPLE
- NO INTERACTION: ZERO AND SPAN CONTROLS
- ELEVATION/SUPPRESSION: UP TO 100% OF RANGE
- POWER RANGE: 8 TO 42 VDC
- RFI-IMMUNE
- TEMPERATURE COEFFICIENTS:
ZERO = $\pm 0.007\%$ / C OF SPAN- TYPICAL
SPAN = $\pm 0.008\%$ / C OF SPAN- TYPICAL
- REPEATABILITY: $\pm 0.002\%$ TYPICAL
- BANDWIDTH: (-3 DB) : 3.2 HZ TYPICAL
- ISOLATION: 600 VDC OR 350 VAC
- POWER SUPPLY EFFECT: $\pm 0.005\%$ OF SPAN
- RESPONSE TIME: 110 MILLISECONDS TYPICAL
- REVERSE POLARITY PROTECTION

TYPICAL APPLICATIONS

MEASUREMENT OF :

- TEMPERATURE
- FLOW
- SPEED
- POSITION
- DISPLACEMENT
- ROTATION
- AC CURRENT
- AC VOLTAGE
- DC MILLIVOLTS

AC INPUT ACX 140 (ISOLATED)	AC INPUT ACX 141 (ISOLATED)	FREQUENCY INPUT FDX 150 (ISOLATED)																																													
INPUT/OUTPUT	INPUT/OUTPUT	INPUT/OUTPUT																																													
<p>INPUT SIGNALS AC CURRENT: ANY 0-0.8 TO 0-5 AMPS AC, BURDEN LESS THAN 0.5 VA (7 MAJOR RANGES) AC VOLTAGE: ANY 0-0.67 TO 0-255 VAC RMS SIGNAL, BURDEN LESS THAN 0.5 VA (21 MAJOR RANGES) ZERO ADJUSTMENT: ±10% SPAN ADJUSTMENT: ±25% INPUT FREQUENCY RANGE: 25-1,000 HZ INPUT OVERLOAD CAPABILITY: AC CURRENT: 15 AMPS CONTINUOUS; 200 AMPS FOR 1 SECOND AC VOLTAGE: 200% OF INPUT SPECIFIED, CONTINUOUS; SUPPRESSION TO 20% OF RANGE</p> <p>OUTPUT SIGNAL: 4-20 MA DC OUTPUT LOOP DRIVE CAPABILITY</p> <p>$R \text{ (OHM)} = \frac{(V \text{ SUPPLY} - V \text{ MINIMUM}) 1.000}{I \text{ OUT MAX. MA}}$</p> <p>V MINIMUM = 8.0 VDC</p> <table border="1" data-bbox="115 779 581 863"> <thead> <tr> <th>I out</th> <th colspan="4">4-20 mA</th> </tr> </thead> <tbody> <tr> <td>V supply</td> <td>12</td> <td>24</td> <td>36</td> <td>42</td> </tr> <tr> <td>R(ohms)</td> <td>200</td> <td>800</td> <td>1400</td> <td>1700</td> </tr> </tbody> </table>	I out	4-20 mA				V supply	12	24	36	42	R(ohms)	200	800	1400	1700	<p>INPUT SIGNALS AC CURRENT: ANY 0-0.8 TO 0-5 AMPS AC, BURDEN LESS THAN 0.5 VA (2 MAJOR RANGES) AC VOLTAGE: ANY 0-0.67 TO 0-255 VAC RMS SIGNAL, BURDEN LESS THAN 0.5 VA (4 MAJOR RANGES) ZERO SUPPRESSION: UP TO 100% OF THE MAJOR RANGE SELECTED IN 16 DIVISIONS OF THE COARSE ZERO ADJUSTMENT SWITCH SPAN: FROM 0-100% FULL SCALE SWITCH SELECTABLE. THE COARSE SPAN SWITCH ADDS 16 DIVISIONS TO EACH MAJOR RANGE. INPUT FREQUENCY RANGE: 25-1,000 HZ INPUT OVERLOAD CAPABILITY: AC CURRENT: 15 AMPS CONT; 200 AMPS, 1 SEC. AC VOLTAGE: 200% OF INPUT SPECIFIED, CONT. OUTPUT SIGNAL: 4-20 MA DC OUTPUT LOOP DRIVE CAPABILITY</p> <p>$R \text{ (OHM)} = \frac{(V \text{ SUPPLY} - V \text{ MINIMUM}) 1.000}{I \text{ OUT MAX. MA}}$</p> <p>V MINIMUM = 8.0 VDC</p> <table border="1" data-bbox="586 779 1052 863"> <thead> <tr> <th>I out</th> <th colspan="4">4-20 mA</th> </tr> </thead> <tbody> <tr> <td>V supply</td> <td>12</td> <td>24</td> <td>36</td> <td>42</td> </tr> <tr> <td>R(ohms)</td> <td>200</td> <td>800</td> <td>1400</td> <td>1700</td> </tr> </tbody> </table>	I out	4-20 mA				V supply	12	24	36	42	R(ohms)	200	800	1400	1700	<p>INPUT SIGNALS VOLTAGE (AMPLITUDE): 10 MV-100 VRMS (0-5 KHZ); 50 MV TO 50 VRMS (5 KHZ TO 30 KHZ) CONTACT: DRY, 2 MA @ 24 VAC RATING FREQUENCY RANGE: 0-30 HZ TO 0-30 KHZ FULL SCALE MAJOR RANGE SWITCH: PROVIDES 11 DISCRETE RANGES WITH THE ZERO CONTROL ADJUSTABLE 10% OF OUTPUT AND SPAN CONTROL ADJUSTABLE FROM 50% TO 100% OF THE MAJOR RANGE SELECTED</p> <p>OUTPUT SIGNAL: 4-20 MA DC OUTPUT LOOP DRIVE CAPABILITY $R \text{ (OHM)} = \frac{(V \text{ SUPPLY} - V \text{ MINIMUM}) 1.000}{I \text{ OUT MAX. MA}}$ V MINIMUM = 8.0 VDC</p> <table border="1" data-bbox="1057 779 1516 863"> <thead> <tr> <th>I out</th> <th colspan="4">4-20 mA</th> </tr> </thead> <tbody> <tr> <td>V supply</td> <td>12</td> <td>24</td> <td>36</td> <td>42</td> </tr> <tr> <td>R(ohms)</td> <td>200</td> <td>800</td> <td>1400</td> <td>1700</td> </tr> </tbody> </table>	I out	4-20 mA				V supply	12	24	36	42	R(ohms)	200	800	1400	1700
I out	4-20 mA																																														
V supply	12	24	36	42																																											
R(ohms)	200	800	1400	1700																																											
I out	4-20 mA																																														
V supply	12	24	36	42																																											
R(ohms)	200	800	1400	1700																																											
I out	4-20 mA																																														
V supply	12	24	36	42																																											
R(ohms)	200	800	1400	1700																																											
<p>PERFORMANCE</p> <p>* CALIBRATED ACCURACY: ±0.25% * INDEPENDENT LINEARITY: ±0.10% MAXIMUM, ±0.04% TYPICAL</p> <p>*10-100% OF SPAN REPEATABILITY: ±0.005% MAX., ±0.002% TYP. ZERO TC: ±0.01% OF SPAN MAX /°C SPAN TC: CURRENT: +0.02% ±0.015% OF SPAN MAX /°C VOLTAGE: -0.015%, ±0.01% OF SPAN MAX /°C LOAD EFFECT: ±0.005% ZERO TO FULL LOAD OUTPUT RIPPLE: 10 mV P/P MAXIMUM RESPONSE TIME: 350 MILLISECONDS (10 TO 90% STEP RESPONSE) BANDWIDTH: (-3 DB): 1 HZ TEMPERATURE RANGE: -25° TO 185°F (-31° TO 85°C) OPERATING; -40° TO 200°F (-40° TO 93°C) STORAGE POWER SUPPLY EFFECT: ±0.005% OVER OPERATING RANGE ISOLATION: INPUT/OUTPUT/CASE: 750VAC, 1,000 VDC NOTE: ALL ACCURACIES ARE GIVEN AS A % OF SPAN.</p>	<p>PERFORMANCE</p> <p>* CALIBRATED ACCURACY: ±0.25% * INDEPENDENT LINEARITY: ±0.10% MAXIMUM, ±0.04% TYPICAL</p> <p>*10-100% OF SPAN REPEATABILITY: ±0.005% MAX., ±0.002% TYP. ZERO TC: ±0.01% OF SPAN MAX /°C SPAN TC: CURRENT: +0.02% ±0.015% OF SPAN MAX /°C VOLTAGE: -0.015%, ±0.01% OF SPAN MAX /°C LOAD EFFECT: ±0.005% ZERO TO FULL LOAD OUTPUT RIPPLE: 10 mV P/P MAXIMUM RESPONSE TIME: 350 MILLISECONDS (10 TO 90% STEP RESPONSE) BANDWIDTH: (-3 DB): 1 HZ TEMPERATURE RANGE: -25° TO 185°F (-31° TO 85°C) OPERATING; -40° TO 200°F (-40° TO 93°C) STORAGE POWER SUPPLY EFFECT: ±0.005% OVER OPERATING RANGE ISOLATION: INPUT/OUTPUT/CASE: 750VAC, 1,000 VDC NOTE: ALL ACCURACIES ARE GIVEN AS A % OF SPAN.</p>	<p>PERFORMANCE</p> <p>* CALIBRATED ACCURACY: ±0.1% * INDEPENDENT LINEARITY: ±0.02% MAXIMUM, ±0.01% TYPICAL</p> <p>REPEATABILITY: ±0.005% MAX., ±0.002% TYP. ZERO TC: ±0.01% OF SPAN MAX /°C SPAN TC: ±0.01% OF SPAN MAX /°C LOAD EFFECT: ±0.005% ZERO TO FULL LOAD OUTPUT RIPPLE: 10 mV P/P MAXIMUM RESPONSE TIME: 550 MILLISECONDS (10 TO 90% STEP RESPONSE) BANDWIDTH: (-3 DB): 0.6 HZ TEMPERATURE RANGE: -25° TO 185°F (-31° TO 85°C) OPERATING; -40° TO 200°F (-40° TO 93°C) STORAGE POWER SUPPLY EFFECT: ±0.005% OVER OPERATING RANGE ISOLATION: INPUT/OUTPUT/CASE: 600 VDC OR 350 VAC WITH RFI NOTE: ALL ACCURACIES ARE GIVEN AS A % OF SPAN.</p>																																													
<p>POWER</p> <p>8 TO 42 VDC: STANDARD</p>	<p>POWER</p> <p>8 TO 42 VDC: STANDARD</p>	<p>POWER</p> <p>8 TO 42 VDC: STANDARD</p>																																													
<p>MECHANICAL</p> <p>ELECTRICAL CLASSIFICATION: GENERAL PURPOSE, CSA CONNECTION: BARRIER TERMINAL STRIPS (0.325" SPACING, NO. 6 SCREWS) CONTROLS: ONE 8-POSITION DIP SWITCH FOR MAJOR RANGE; TWO MULTITURN POTENTIOMETERS FOR FINE ZERO AND SPAN CONTROL. MOUNTING: SURFACE, SNAP-TRACK, DIN, OR NEMA 4, 7, & 12 WEIGHT: NET UNIT: 8 OZ. (228 GRAMS); SHIPPING: NOMINAL 1 POUND (455 GRAMS)</p>	<p>MECHANICAL</p> <p>ELECTRICAL CLASSIFICATION: GENERAL PURPOSE, CSA CONNECTION: BARRIER TERMINAL STRIPS (0.325" SPACING, NO. 6 SCREWS) CONTROLS: ONE 8-POSITION DIP SWITCH FOR MAJOR RANGE; TWO 16-POSITION ROTARY SWITCHES FOR COARSE ZERO AND SPAN CONTROL; TWO MULTITURN POTENTIOMETERS FOR FINE ZERO AND SPAN CONTROL. MOUNTING: SURFACE, SNAP-TRACK, DIN, OR NEMA 4, 7, & 12 WEIGHT: NET UNIT: 8 OZ. (228 GRAMS); SHIPPING: NOMINAL 1 POUND (455 GRAMS)</p>	<p>MECHANICAL</p> <p>ELECTRICAL CLASSIFICATION: GENERAL PURPOSE, CSA CONNECTION: BARRIER TERMINAL STRIPS (0.325" SPACING, NO. 6 SCREWS) CONTROLS: ONE 16-POSITION ROTARY SWITCH FOR RANGE CONTROL; FOUR MULTITURN POTENTIOMETERS FOR ZERO, SPAN, SENSITIVITY, AND HYSTERESIS CONTROL MOUNTING: SURFACE, SNAP-TRACK, DIN, OR NEMA 4, 7, & 12 WEIGHT: NET UNIT: 8 OZ. (228 GRAMS); SHIPPING: NOMINAL 1 POUND (455 GRAMS)</p>																																													
<p>OPTIONS</p> <p>H 13 THROUGH H 23 LPI MOUNTING LOOP POWERED INDICATOR</p>	<p>OPTIONS</p> <p>H 13 THROUGH H 23 LPI MOUNTING LOOP POWERED INDICATOR</p>	<p>OPTIONS</p> <p>H 13 THROUGH H 23 LPI MOUNTING LOOP POWERED INDICATOR</p>																																													

MV INPUT MVX 106 (NON-ISOLATED)	MV INPUT MVX 126 (ISOLATED)	POTENTIOMETER INPUT PTX 173 (NON-ISOLATED)																																													
INPUT/OUTPUT	INPUT/OUTPUT	INPUT/OUTPUT																																													
<p>INPUT SIGNALS 0.5 mV TO 100 mV SPAN (Z IN GREATER THAN 10 MEGOHMS) ZERO SUPPRESSION: UP TO 100% OF THE MAJOR RANGE SELECTED IN 16 DIVISIONS OF THE COARSE ZERO ADJUSTMENT SWITCH SPAN: FROM 0.5 mV TO 100 mV FULL SCALE SWITCH SELECTABLE. THE COARSE SPAN SWITCH ADDS 16 DIVISIONS TO EACH MAJOR RANGE. UPSCALE/DOWNSCALE PROTECTION: OPTIONAL</p> <p>OUTPUT SIGNAL: 4-20 mA DC OUTPUT LOOP DRIVE CAPABILITY</p> <p>$R \text{ (OHM)} = \frac{(V \text{ SUPPLY} - V \text{ MINIMUM}) 1.000}{I \text{ OUT MAX. MA}}$</p> <p>V MINIMUM = 8.0 VDC</p> <table border="1" data-bbox="94 793 537 877"> <thead> <tr> <th>I out</th> <th colspan="4">4-20 mA</th> </tr> </thead> <tbody> <tr> <td>V supply</td> <td>12</td> <td>24</td> <td>36</td> <td>42</td> </tr> <tr> <td>R(ohms)</td> <td>200</td> <td>800</td> <td>1400</td> <td>1700</td> </tr> </tbody> </table>	I out	4-20 mA				V supply	12	24	36	42	R(ohms)	200	800	1400	1700	<p>INPUT SIGNALS 0.5 mV TO 100 mV SPAN (Z IN GREATER THAN 10 MEGOHMS) ZERO SUPPRESSION: UP TO 100% OF THE MAJOR RANGE SELECTED IN 16 DIVISIONS OF THE COARSE ZERO ADJUSTMENT SWITCH SPAN: FROM 0.5 mV TO 100 mV FULL SCALE SWITCH SELECTABLE. THE COARSE SPAN SWITCH ADDS 16 DIVISIONS TO EACH MAJOR RANGE. UPSCALE/DOWNSCALE PROTECTION: OPTIONAL</p> <p>OUTPUT SIGNAL: 4-20 mA DC OUTPUT LOOP DRIVE CAPABILITY</p> <p>$R \text{ (OHM)} = \frac{(V \text{ SUPPLY} - V \text{ MINIMUM}) 1.000}{I \text{ OUT MAX. MA}}$</p> <p>V MINIMUM = 8.0 VDC</p> <table border="1" data-bbox="561 793 1005 877"> <thead> <tr> <th>I out</th> <th colspan="4">4-20 mA</th> </tr> </thead> <tbody> <tr> <td>V supply</td> <td>12</td> <td>24</td> <td>36</td> <td>42</td> </tr> <tr> <td>R(ohms)</td> <td>200</td> <td>800</td> <td>1400</td> <td>1700</td> </tr> </tbody> </table>	I out	4-20 mA				V supply	12	24	36	42	R(ohms)	200	800	1400	1700	<p>INPUT SIGNALS POTENTIOMETERS/SLIDEWIRE SENSORS: 3 WIRE 50 OHM TO 100 K OHM RESISTANCE SPANS: STANDARD ZERO SUPPRESSION: UP TO 100% OF THE POTENTIOMETER ROTATION SELECTED IN 16 DIVISIONS OF THE COARSE ZERO ADJUSTMENT SWITCH. SPAN: FROM 0-100% FULL SCALE SWITCH SELECTABLE. THE COARSE SPAN SWITCH ADDS 16 RANGE DIVISIONS.</p> <p>OUTPUT SIGNAL: 4-20 mA DC OUTPUT LOOP DRIVE CAPABILITY</p> <p>$R \text{ (OHM)} = \frac{(V \text{ SUPPLY} - V \text{ MINIMUM}) 1.000}{I \text{ OUT MAX. MA}}$</p> <p>V MINIMUM = 8.0 VDC</p> <table border="1" data-bbox="1029 793 1489 877"> <thead> <tr> <th>I out</th> <th colspan="4">4-20 mA</th> </tr> </thead> <tbody> <tr> <td>V supply</td> <td>12</td> <td>24</td> <td>36</td> <td>42</td> </tr> <tr> <td>R(ohms)</td> <td>200</td> <td>800</td> <td>1400</td> <td>1700</td> </tr> </tbody> </table>	I out	4-20 mA				V supply	12	24	36	42	R(ohms)	200	800	1400	1700
I out	4-20 mA																																														
V supply	12	24	36	42																																											
R(ohms)	200	800	1400	1700																																											
I out	4-20 mA																																														
V supply	12	24	36	42																																											
R(ohms)	200	800	1400	1700																																											
I out	4-20 mA																																														
V supply	12	24	36	42																																											
R(ohms)	200	800	1400	1700																																											
PERFORMANCE	PERFORMANCE	PERFORMANCE																																													
<p>* CALIBRATED ACCURACY: 0.1% INDEPENDENT LINEARITY: ±0.01% MAXIMUM, ±0.006% TYPICAL (14-BIT DIGITAL LINEARITY) REPEATABILITY: ±0.005% MAX., ±0.002% TYP. ZERO TC: ± $\frac{0.025}{\text{INPUT SPAN (mV)}} + 0.005$ % OF SPAN MAX./ °C SPAN TC: ±0.008% OF SPAN MAX./°C LOAD EFFECT: ±0.005% ZERO TO FULL LOAD OUTPUT RIPPLE: 10 mV P/P MAXIMUM RESPONSE TIME: 110 MILLISECONDS (10 TO 90% STEP RESPONSE) BANDWIDTH: (-3 DB): 3.2 HZ TEMPERATURE RANGE: -25° TO 185°F (-31° TO 85°C) OPERATING; -40° TO 200°F (-40° TO 93°C) STORAGE POWER SUPPLY EFFECT: ±0.005% OVER OPERATING RANGE NOTE: ALL ACCURACIES ARE GIVEN AS A % OF SPAN.</p>	<p>* CALIBRATED ACCURACY: 0.1% INDEPENDENT LINEARITY: ±0.01% MAXIMUM, ±0.006% TYPICAL (14-BIT DIGITAL LINEARITY) REPEATABILITY: ±0.005% MAX., ±0.002% TYP. ZERO TC: ± $\frac{0.025}{\text{INPUT SPAN (mV)}} + 0.005$ % OF SPAN MAX./ °C SPAN TC: ±0.008% OF SPAN MAX./°C LOAD EFFECT: ±0.005% ZERO TO FULL LOAD OUTPUT RIPPLE: 10 mV P/P MAXIMUM RESPONSE TIME: 110 MILLISECONDS (10 TO 90% STEP RESPONSE) BANDWIDTH: (-3 DB): 3.2 HZ TEMPERATURE RANGE: -25° TO 185°F (-31° TO 85°C) OPERATING; -40° TO 200°F (-40° TO 93°C) STORAGE POWER SUPPLY EFFECT: ±0.005% OVER OPERATING RANGE ISOLATION: INPUT/OUTPUT/CASE: 600 VDC. OR 350 VAC NOTE: ALL ACCURACIES ARE GIVEN AS A % OF SPAN.</p>	<p>* CALIBRATED ACCURACY: ±0.1% *INDEPENDENT LINEARITY: ±0.01% MAXIMUM, ±0.006% TYPICAL (14-BIT DIGITAL LINEARITY) REPEATABILITY: ±0.005% MAX., ±0.002% TYP. ZERO TC: ±0.007% OF SPAN MAX./°C SPAN TC: ±0.010% OF SPAN MAX./°C LOAD EFFECT: ±0.005% ZERO TO FULL LOAD OUTPUT RIPPLE: 10 mV P/P MAXIMUM RESPONSE TIME: 110 MILLISECONDS (10 TO 90% STEP RESPONSE) BANDWIDTH: (-3 DB): 3.2 HZ TEMPERATURE RANGE: -25° TO 185°F (-31° TO 85°C) OPERATING; -40° TO 200°F (-40° TO 93°C) STORAGE POWER SUPPLY EFFECT: ±0.005% OVER OPERATING RANGE NOTE: ALL ACCURACIES ARE GIVEN AS A % OF SPAN.</p>																																													
POWER	POWER	POWER																																													
8 TO 42 VDC: STANDARD	8 TO 42 VDC: STANDARD	8 TO 42 VDC: STANDARD																																													
MECHANICAL	MECHANICAL	MECHANICAL																																													
<p>ELECTRICAL CLASSIFICATION: GENERAL PURPOSE, CSA CONNECTION: BARRIER TERMINAL STRIPS (0.325" SPACING, NO. 6 SCREWS) CONTROLS: ONE 8-POSITION DIP SWITCH FOR MAJOR RANGE; TWO 16-POSITION ROTARY SWITCHES FOR COARSE ZERO AND SPAN CONTROL; TWO MULTITURN POTENTIOMETERS FOR FINE ZERO AND SPAN CONTROL. MOUNTING: SURFACE, SNAP-TRACK, DIN, OR NEMA 4, 7, & 12 WEIGHT: NET UNIT: 8 OZ. (228 GRAMS); SHIPPING: NOMINAL 1 POUND (455 GRAMS)</p>	<p>ELECTRICAL CLASSIFICATION: GENERAL PURPOSE, CSA CONNECTION: BARRIER TERMINAL STRIPS (0.325" SPACING, NO. 6 SCREWS) CONTROLS: ONE 8-POSITION DIP SWITCH FOR MAJOR RANGE; TWO 16-POSITION ROTARY SWITCHES FOR COARSE ZERO AND SPAN CONTROL; TWO MULTITURN POTENTIOMETERS FOR FINE ZERO AND SPAN CONTROL. MOUNTING: SURFACE, SNAP-TRACK, DIN, OR NEMA 4, 7, & 12 WEIGHT: NET UNIT: 8 OZ. (228 GRAMS); SHIPPING: NOMINAL 1 POUND (455 GRAMS)</p>	<p>ELECTRICAL CLASSIFICATION: GENERAL PURPOSE, CSA CONNECTION: BARRIER TERMINAL STRIPS (0.325" SPACING, NO. 6 SCREWS) CONTROLS: TWO 16-POSITION ROTARY SWITCHES FOR COARSE ZERO AND SPAN CONTROL; TWO MULTITURN POTENTIOMETERS FOR FINE ZERO AND SPAN CONTROL MOUNTING: SURFACE, SNAP-TRACK, DIN, OR NEMA 4, 7, & 12 WEIGHT: NET UNIT: 8 OZ. (228 GRAMS); SHIPPING: NOMINAL 1 POUND (455 GRAMS)</p>																																													
OPTIONS	OPTIONS	OPTIONS																																													
<p>H 13 THROUGH H 23 LPI MOUNTING LOOP POWERED INDICATOR I 14 VOLTAGE/CURRENT INPUTS</p>	<p>H 13 THROUGH H 23 LPI MOUNTING LOOP POWERED INDICATOR I 14 VOLTAGE/CURRENT INPUTS</p>	<p>H 13 THROUGH H 23 LPI MOUNTING LOOP POWERED INDICATOR</p>																																													

RTD INPUT RBX 174 (NON-ISOLATED)	RTD INPUT RBX 172 (ISOLATED)	T/C INPUT TCX 126 (ISOLATED)																																													
INPUT/OUTPUT	INPUT/OUTPUT	INPUT/OUTPUT																																													
<p>INPUT SIGNALS RESISTANCE BULB SENSOR: 2, 3, OR 4 WIRE TYPES CONFORMANCE TO RTD CURVES: 0.15% MAX. 1 TO 400 OHM RESISTANCE SPANS: STANDARD ZERO SUPPRESSION: UP TO 100% OF THE MAJOR RANGE SELECTED IN 16 DIVISIONS OF THE COARSE ZERO AD- JUSTMENT SWITCH. SPAN: FROM 0-100% FULL SCALE SWITCH SELECTABLE. THE COARSE SPAN SWITCH ADDS 16 DIVISIONS TO EACH MAJOR RANGE. LEAD COMPENSATION: 1% MAXIMUM ERROR OF DIFFERENTIAL LEAD RESISTANCE</p> <p>OUTPUT SIGNAL: 4-20 mA DC OUTPUT LOOP DRIVE CAPABILITY</p> <p>$R \text{ (OHM)} = \frac{V \text{ SUPPLY} - V \text{ MINIMUM}}{I \text{ OUT MAX. MA}} \cdot 1.000$</p> <p>V MINIMUM = 8.0 VDC</p> <table border="1" data-bbox="105 640 552 724"> <thead> <tr> <th>I out</th> <th colspan="4">4-20 mA</th> </tr> </thead> <tbody> <tr> <td>V supply</td> <td>12</td> <td>24</td> <td>36</td> <td>42</td> </tr> <tr> <td>R(ohms)</td> <td>200</td> <td>800</td> <td>1400</td> <td>1700</td> </tr> </tbody> </table>	I out	4-20 mA				V supply	12	24	36	42	R(ohms)	200	800	1400	1700	<p>INPUT SIGNALS RESISTANCE BULB SENSOR: 2, 3, OR 4 WIRE TYPES CONFORMANCE TO RTD CURVES: 0.15% MAX. 1 TO 400 OHM RESISTANCE SPANS: STANDARD ZERO SUPPRESSION: UP TO 100% OF THE MAJOR RANGE SELECTED IN 16 DIVISIONS OF THE COARSE ZERO AD- JUSTMENT SWITCH. SPAN: FROM 0-100% FULL SCALE SWITCH SELECTABLE. THE COARSE SPAN SWITCH ADDS 16 DIVISIONS TO EACH MAJOR RANGE. LEAD COMPENSATION: 1% MAXIMUM ERROR OF DIFFERENTIAL LEAD RESISTANCE</p> <p>OUTPUT SIGNAL: 4-20 mA DC OUTPUT LOOP DRIVE CAPABILITY</p> <p>$R \text{ (OHM)} = \frac{V \text{ SUPPLY} - V \text{ MINIMUM}}{I \text{ OUT MAX. MA}} \cdot 1.000$</p> <p>V MINIMUM = 8.0 VDC</p> <table border="1" data-bbox="584 640 1031 724"> <thead> <tr> <th>I out</th> <th colspan="4">4-20 mA</th> </tr> </thead> <tbody> <tr> <td>V supply</td> <td>12</td> <td>24</td> <td>36</td> <td>42</td> </tr> <tr> <td>R(ohms)</td> <td>200</td> <td>800</td> <td>1400</td> <td>1700</td> </tr> </tbody> </table>	I out	4-20 mA				V supply	12	24	36	42	R(ohms)	200	800	1400	1700	<p>INPUT SIGNALS *THERMOCOUPLE: ALL STANDARD ISA CALIBRATION (B, E, J, K, R, S, T), -20 MV TO 100 MV SPANS (Z IN GREATER THAN 1 MEGOHM) ZERO SUPPRESSION: UP TO 100% OF THE MAJOR RANGE SELECTED IN 16 DIVISIONS OF THE COARSE ZERO AD- JUSTMENT SWITCH. SPAN: FROM 0.5 MV TO 100 MV FULL SCALE SWITCH SELECTABLE. THE COARSE SPAN SWITCH ADDS 16 DIVI- SIONS TO EACH MAJOR RANGE. UPSCALE/DOWNSCALE BURNOUT PROTECTION: STAN- DARD BURNOUT CURRENT: 0.1 MICRO AMPERES-NOMINAL *CONSULT FACTORY FOR OTHER T/C TYPES.</p> <p>OUTPUT SIGNAL: 4-20 mA DC OUTPUT LOOP DRIVE CAPABILITY</p> <p>$R \text{ (OHM)} = \frac{V \text{ SUPPLY} - V \text{ MINIMUM}}{I \text{ OUT MAX. MA}} \cdot 1.000$</p> <p>V MINIMUM = 8.0 VDC</p> <table border="1" data-bbox="1063 640 1510 724"> <thead> <tr> <th>I out</th> <th colspan="4">4-20 mA</th> </tr> </thead> <tbody> <tr> <td>V supply</td> <td>12</td> <td>24</td> <td>36</td> <td>42</td> </tr> <tr> <td>R(ohms)</td> <td>200</td> <td>800</td> <td>1400</td> <td>1700</td> </tr> </tbody> </table>	I out	4-20 mA				V supply	12	24	36	42	R(ohms)	200	800	1400	1700
I out	4-20 mA																																														
V supply	12	24	36	42																																											
R(ohms)	200	800	1400	1700																																											
I out	4-20 mA																																														
V supply	12	24	36	42																																											
R(ohms)	200	800	1400	1700																																											
I out	4-20 mA																																														
V supply	12	24	36	42																																											
R(ohms)	200	800	1400	1700																																											
PERFORMANCE	PERFORMANCE	PERFORMANCE																																													
<p>* CALIBRATED ACCURACY: ±0.1% *INDEPENDENT LINEARITY: ±0.025% MAXIMUM, ±0.01% TYPICAL REPEATABILITY: ±0.005% MAX., ±0.002% TYP. ZERO TC: $\pm \frac{0.05}{\text{INPUT SPAN (OHMS)}} + 0.005$ % OF SPAN/ °C MAX. SPAN TC: ±0.008% OF SPAN MAX. / °C CONFORMANCE TO RTD CURVES: 0.15% MAX. LOAD EFFECT: ±0.005% ZERO TO FULL LOAD OUTPUT RIPPLE: 10 MV P/P MAXIMUM RESPONSE TIME: 110 MILLISECONDS (10 TO 90% STEP RESPONSE) BANDWIDTH: (-3 DB): 3.2 HZ TEMPERATURE RANGE: -25° TO 185°F (-31° TO 85°C) OPERATING; -40° TO 200°F (-40° TO 93°C) STORAGE POWER SUPPLY EFFECT: ±0.005% OVER OPERATING RANGE</p> <p>NOTE: ALL ACCURACIES ARE GIVEN AS A % OF SPAN.</p>	<p>* CALIBRATED ACCURACY: ±0.1% *INDEPENDENT LINEARITY: ±0.025% MAXIMUM, ±0.01% TYPICAL REPEATABILITY: ±0.005% MAX., ±0.002% TYP. ZERO TC: $\pm \frac{0.05}{\text{INPUT SPAN (OHMS)}} + 0.005$ % OF SPAN/ °C MAX. SPAN TC: ±0.008% OF SPAN MAX. / °C CONFORMANCE TO RTD CURVES: 0.15% MAX. LOAD EFFECT: ±0.005% ZERO TO FULL LOAD OUTPUT RIPPLE: 10 MV P/P MAXIMUM RESPONSE TIME: 110 MILLISECONDS (10 TO 90% STEP RESPONSE) BANDWIDTH: (-3 DB): 3.2 HZ TEMPERATURE RANGE: -25° TO 185°F (-31° TO 85°C) OPERATING; -40° TO 200°F (-40° TO 93°C) STORAGE POWER SUPPLY EFFECT: ±0.005% OVER OPERATING RANGE</p> <p>ISOLATION: INPUT/OUTPUT/CASE: 600VDC, 350 VAC NOTE: ALL ACCURACIES ARE GIVEN AS A % OF SPAN.</p>	<p>* CALIBRATED ACCURACY: ±0.1% *INDEPENDENT LINEARITY: ±0.01% MAXIMUM, ±0.006% TYPICAL (14-BIT DIGITAL LINEARITY) REPEATABILITY: ±0.005% MAX., ±0.002% TYP. ZERO TC: $\pm \frac{0.025}{\text{INPUT SPAN (MV)}} + 0.007$ % OF SPAN/ °C MAX. SPAN TC: ±0.008% OF SPAN MAX. / °C LOAD EFFECT: ±0.005% ZERO TO FULL LOAD OUTPUT RIPPLE: 10 MV P/P MAXIMUM RESPONSE TIME: 110 MILLISECONDS (10 TO 90% STEP RESPONSE) BANDWIDTH: (-3 DB): 3.2 HZ TEMPERATURE RANGE: -25° TO 185°F (-31° TO 85°C) OPERATING; -40° TO 200°F (-40° TO 93°C) STORAGE POWER SUPPLY EFFECT: ±0.005% OVER OPERATING RANGE</p> <p>ISOLATION: INPUT/OUTPUT/CASE: 600VDC, 350 VAC COLD JUNCTION COMPENSATION ERROR: 1.5 °C MAX (0 TO 50 °C BURNOUT CURRENT: 0.1 MICRO AMPS- NOMINAL NOTE: ALL ACCURACIES ARE GIVEN AS A % OF SPAN.</p>																																													
POWER	POWER	POWER																																													
8 TO 42 VDC: STANDARD	8 TO 42 VDC: STANDARD	8 TO 42 VDC: STANDARD																																													
OPTIONS	OPTIONS	OPTIONS																																													
<table border="0"> <tr> <td>H 13 THROUGH H 23</td> <td>MOUNTING</td> </tr> <tr> <td>LPI</td> <td>LOOP POWERED INDICATOR</td> </tr> </table>	H 13 THROUGH H 23	MOUNTING	LPI	LOOP POWERED INDICATOR	<table border="0"> <tr> <td>H 13 THROUGH H 23</td> <td>MOUNTING</td> </tr> <tr> <td>LPI</td> <td>LOOP POWERED INDICATOR</td> </tr> </table>	H 13 THROUGH H 23	MOUNTING	LPI	LOOP POWERED INDICATOR	<table border="0"> <tr> <td>H 13 THROUGH H 23</td> <td>MOUNTING</td> </tr> <tr> <td>LPI</td> <td>LOOP POWERED INDICATOR</td> </tr> </table>	H 13 THROUGH H 23	MOUNTING	LPI	LOOP POWERED INDICATOR																																	
H 13 THROUGH H 23	MOUNTING																																														
LPI	LOOP POWERED INDICATOR																																														
H 13 THROUGH H 23	MOUNTING																																														
LPI	LOOP POWERED INDICATOR																																														
H 13 THROUGH H 23	MOUNTING																																														
LPI	LOOP POWERED INDICATOR																																														
MECHANICAL																																															
<p>ELECTRICAL CLASSIFICATION: GENERAL PURPOSE, CSA CONNECTION: BARRIER TERMINAL STRIPS (0.325" SPACING, NO. 6 SCREWS) ELECTRICAL CLASSIFICATION: GENERAL PURPOSE, CSA CONNECTION: BARRIER TERMINAL STRIPS (0.325" SPACING, NO. 6 SCREWS) CONTROLS: ONE 8-POSITION DIP SWITCH FOR MAJOR RANGE; TWO 16-POSITION ROTARY SWITCHES FOR COARSE ZERO AND SPAN CONTROL; TWO MULTITURN POTENTIOM- ETERS FOR FINE ZERO AND SPAN CONTROL.</p> <p>MOUNTING: SURFACE, SNAP-TRACK, DIN, OR NEMA 4, 7, & 12 WEIGHT: NET UNIT: 8 OZ. (228 GRAMS); SHIPPING: NOMINAL 1 POUND (455 GRAMS)</p>																																															

THE ADTECH 100 SERIES TWO-WIRE TRANSMITTERS PROVIDE FIELD MOUNTED EFFICIENCY AND EASE OF WIRING IN A COMPACT PACKAGE. THE UNITS CONVERT SENSOR INPUTS TO THE INDUSTRY STANDARD 4-20 MA DC TWO-WIRE LOOP OUTPUT FOR INTERFACE DIRECTLY WITH PLC'S, DCS'S AND PROCESS COMPUTERS.

MOST UNITS PROVIDE INDEPENDENT LINEARITY EQUIVALENT TO 14-BIT DIGITAL ACCURACY AND INCLUDE USER FRIENDLY FEATURES SUCH AS WIDE RANGING AND NON-INTERACTIVE ZERO AND SPAN CONTROLS.

THE COMPACT MOUNTING STYLE ALLOWS HIGH DENSITY MOUNTING IN NEW OR EXISTING FIELD MOUNTED OR CONTROL PANEL ENCLOSURES.

THESE UNITS ARE DESIGNED FOR INDUSTRIAL (FIELD) ENVIRONMENTS. THE HOUSING IS MADE OF RUGGED DIE CAST ALUMINUM WITH AN EPOXY PAINT FINISH AND IS GASKETED/SEALED FOR PROTECTION AGAINST CORROSION, MOISTURE, AND DUST. BARRIER TERMINAL STRIPS ARE PROVIDED FOR POSITIVE FIELD CONNECTIONS.

RFI PROTECTION, MEETING SAMA PMC 33.1C AND EMI INTERFERENCE, IS PROVIDED AS STANDARD.

MOUNTING OPTIONS FOR NEMA 4,7,12,SNAP TRACK, AND DIN ARE AVAILABLE.

REVERSE POLARITY PROTECTION AND CURRENT LIMITING ARE SUPPLIED AS STANDARD.

THE POWER RANGE OF 8 TO 42 VDC PROVIDES VALUABLE ADDED DRIVE CAPABILITY.

THE INPUT CAN BE FACTORY SET TO ORDER AS SPECIFIED (NO CHARGE) OR RECONFIGURED IN THE FIELD BY SIMPLY ADJUSTING SWITCHES AND MULTI-TURN POTENTIOMETERS.

INTEGRAL LCD FIELD INDICATOR (LPI 40) IS OPTIONALLY AVAILABLE.

AC TO DC OR DC TO DC INSTRUMENT POWER SUPPLIES ARE AVAILABLE. THE IPS 2402 AC/DC POWERS UP TO 2 UNITS. THE IPS 2416 AC/DC OR DC/DC POWERS UP TO 16 UNITS. DIN, SURFACE, SNAP TACK OR NEMA MOUNTINGS ARE AVAILABLE.

Connections

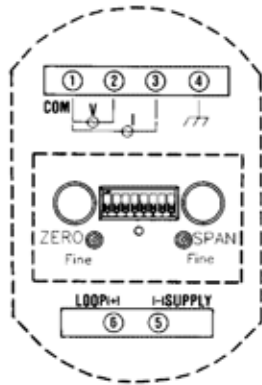

ACX 140

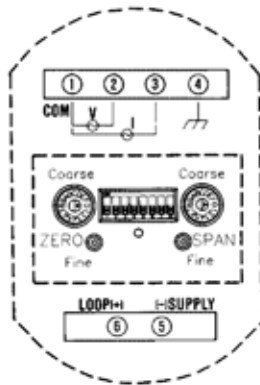

ACX 141

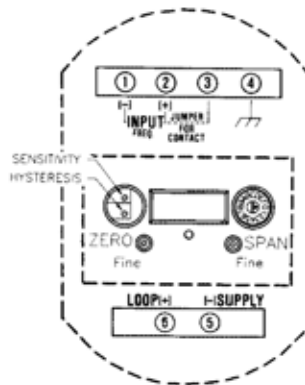

FDX 150

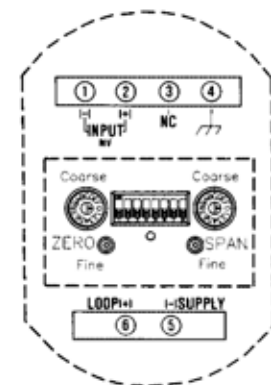

MVX 106 & MVX 126

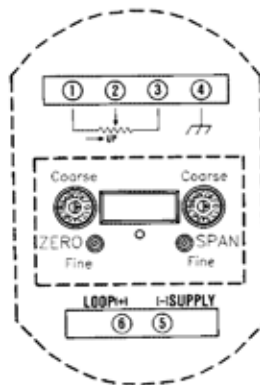

PTX 173

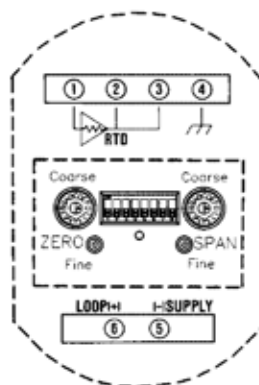

RBX 172 & RBX 174

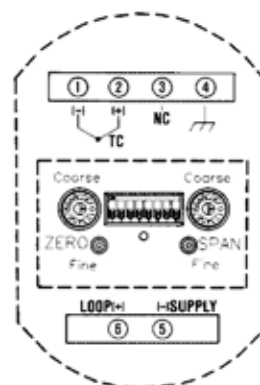

TCX 126

Outline & Mounting

Surface (Standard)

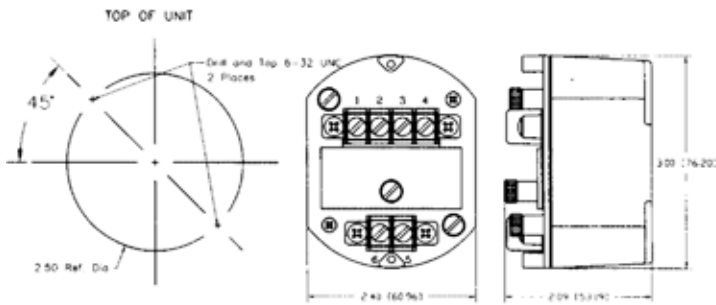

Surface Option H 22

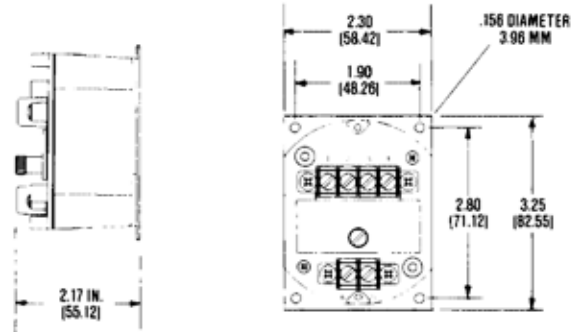

DIN Option H 20A

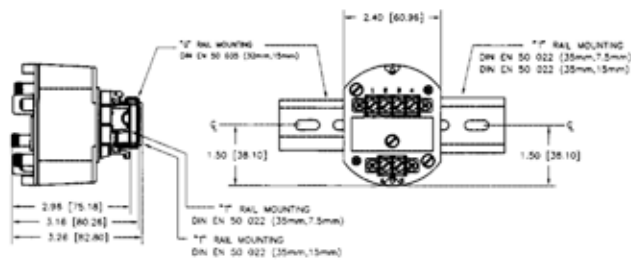

Snap Track Options H 18 and H 19

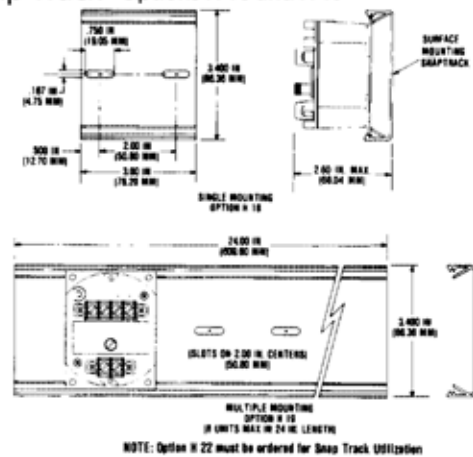

NEMA 4 & 12 Options H 13A and H 14A

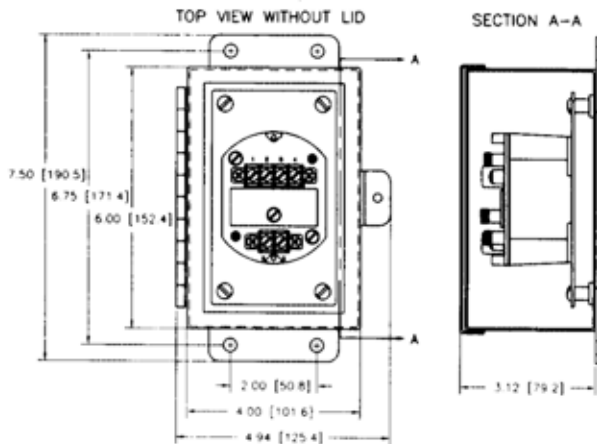

NEMA 7 Option H15

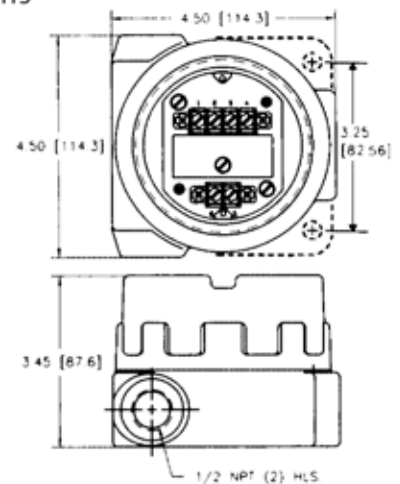

Note: The LPI 40 enclosure is 5.82 (147.8) high.